

Accuracy of Ceramic Mould Filling with Liquid AlSi9 Aluminium Alloy in the Process Using Back-pressure

A. Karwiński ^{a*}, R. Haratym ^b, R. Biernacki ^c

^a Foundry Research Institute, Zakopiańska 73, 30-418 Kraków, Poland

^b University of Ecology and Management, Wawelska 14, 02-061 Warszawa, Poland

^c Warsaw University of Technology, Institute of Manufacturing Technology, Narbutta 85, 02-524 Warszawa, Poland

* Corresponding author. E-mail address: akarw@iod.krakow.pl

Received 20.06.2012; accepted in revised form 04.09.2012

Abstract

The paper presents the effect of suction pressure exerted on the liquid AlSi alloy when it is introduced into a ceramic mould made in the investment process and the results compared with data obtained on gravity poured castings.

The study used special pattern sets and ceramic moulds made with the alternately applied soluble silicate binder and ethyl silicate. Additionally, self-supported moulds based entirely on the Ekosil binder were used. In the analysis of castings, the following parameters were examined: a linear dimensional accuracy, the state of surface microgeometry and the possibility of metal penetration into a complex ceramic mould, allowing also for the presence of capillary phenomena. In the process of casting with back-pressure, the pressure values of 500 hPa, 600 hPa and 700 hPa were applied in the chamber where the ceramic mould was located, with the temperature of the said mould kept at a level of $150 \pm 10^\circ\text{C}$.

Keywords: Casting with back-pressure, Investment casting process, Capillarity phenomena

1. Current state of the problem

The process of casting with back-pressure, developed by Hitchiner Manufacturing Co., is one of the most modern and promising methods for making high-accuracy castings, also by the lost wax process. Typical applications for castings made with the back-pressure are disclosed in [1, 2, 3, 4, 5]. Those studies also evaluate, in a very general way, parameters such as the dimensional accuracy, surface microgeometry, and the like ones.

The quality of castings made in the process using back-pressure has been discussed in more detail in [6, 7].

This paper presents a comprehensive comparison of the process using back-pressure and the traditional lost wax process, following the adopted criteria for casting quality evaluation.

2. Studies of the accuracy of ceramic mould filling with liquid AlSi9 aluminium alloy in the process using back-pressure and in the common investment casting process

2.1. Test materials

Patterns were made from the following composition: 50% paraffin, 40% stearin and 10% Montana wax.

Thin-wall patterns indicated in Figure 1 were made in the following way:

- 1) the total pattern surface area was 10 cm² and 15 cm² with the length of 50 mm,
- 2) patterns with a thickness from 0.2 to 0.7 mm were made from polystyrene,
- 3) patterns with a thickness above 0.7 mm were made from paper impregnated with an adequately thick layer of the liquid pattern material.

Two types of the nine-layer ceramic moulds were prepared, based on the ceramic material, which was crystal quartz:

- 1) type I - colloidal silica binder (layers with odd numbers) alternately with hydrolysed ethyl silicate 40,

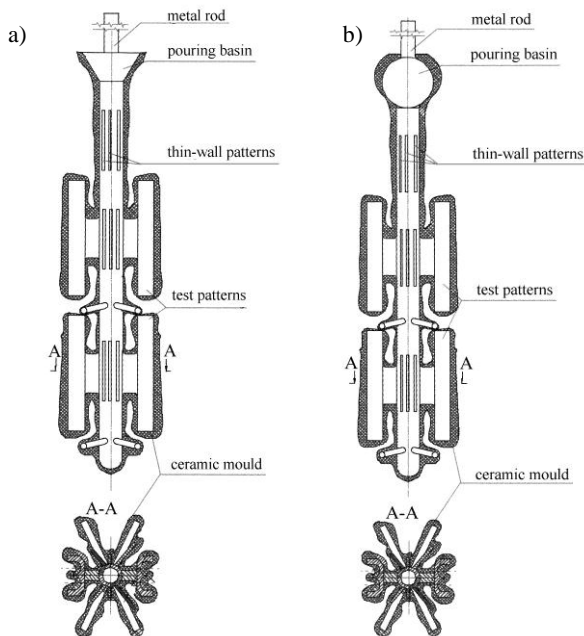

Fig. 1. Pattern set coated with the applied layers of ceramic mould material:

a) for gravity casting; b) for casting with back-pressure

Twelve sets of ceramic moulds were made. Seven sets were designed for castings made in the process using back-pressure, and five to make castings at an atmospheric pressure. In all cases, AlSi9 silumin was the material cast.

2.2. Methodology

After pattern removal the ceramic moulds were subjected to heat treatment at 950°C for 3 h. Then they were cooled to room temperature at a cooling rate of 3°C/min.

Test castings were made by the following procedure:

- 1) Pattern sets (Fig. 1b) for casting with back-pressure were fixed fast in a suitable chamber (Fig. 2) which, while on the test stand, was connected through a surge tank of 150 litres capacity to a vacuum pump and heated (operations parallel in time) to a temperature of 150±10°C.
- 2) The following parameters were applied during casting with back-pressure:
 - laminar air flow forced by the surge tank,
 - final pressure in the chamber with mould fixed inside - 500 hPa, 600 hPa, 700 hPa,
 - AlSi alloy temperature on suction of metal to ceramic mould - 680±10°C.
- 3) For castings made by a common lost wax process, the temperature of the liquid AlSi alloy was 710 ± 10°C with the ceramic mould temperature kept at a level of 400 ± 20°C.

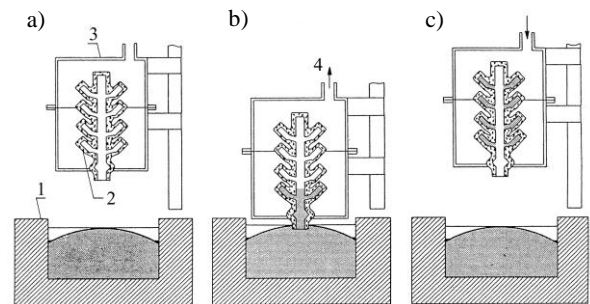

Fig. 2. The principle of operation of a method using back-pressure for filling of investment moulds:

a) mould placed in a vacuum chamber, b) mould pouring, c) mould with metal solidified in the cavities (metal remaining in the down gate flew back to the crucible)

1 - crucible with liquid alloy, 2 - ceramic investment mould, 3 - vacuum chamber, 4 - vacuum pump

3. Results

3.1. Filling of thin-wall castings

Measurements were taken on ceramic moulds with 60 different wall thicknesses (for the process using back-pressure) and with 40 different wall thicknesses for the conventional lost wax process.

In the method using back-pressure, 100% filling of thin-wall castings was observed for the dimensions of more than 0.9 mm. Moreover, even the casting walls of 0.2 mm thickness were filled in 55%. Figure 4 shows the discussed results, obtained under the pressure of 500 hPa in a chamber where the ceramic mould has been located. In the case of thin-wall castings made by the lost wax process (Fig. 3), the smallest wall thicknesses obtained had the dimensions from 0.7 to 0.9 mm at 56% filling. The best degree of filling equal to 83% was obtained for walls from 1.1 to 1.3 mm.

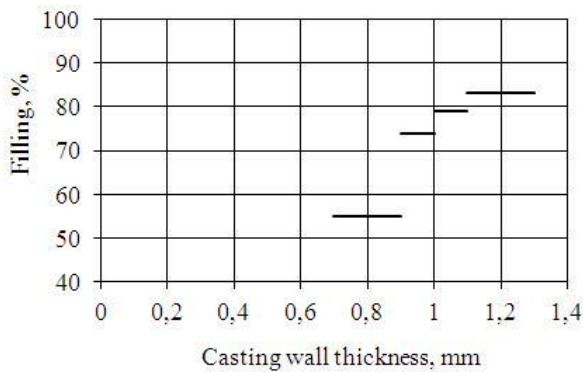

Fig. 3. Filling of ceramic mould cavity with AlSi9 alloy under the effect of atmospheric pressure

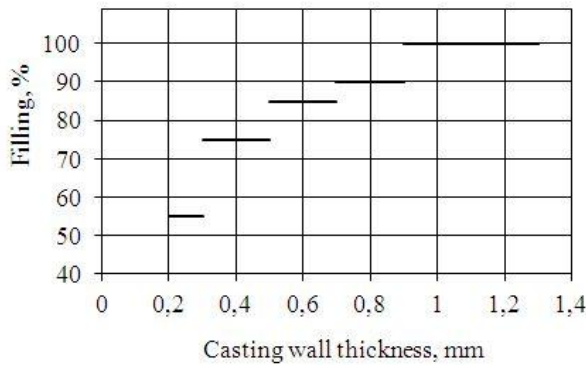

Fig. 4. Filling of ceramic mould cavity with AlSi9 alloy under the effect of 500 hPa pressure

Figure 5 compares the results of filling the thin walls in the process with back-pressure and in casting by the traditional lost wax technique. The whole population of the examined objects was taken into consideration. The differences were quite significant both when different pressures were used in the process with back-pressure and when the results were compared with the traditional casting. Much better results were obtained for casting with back-pressure.

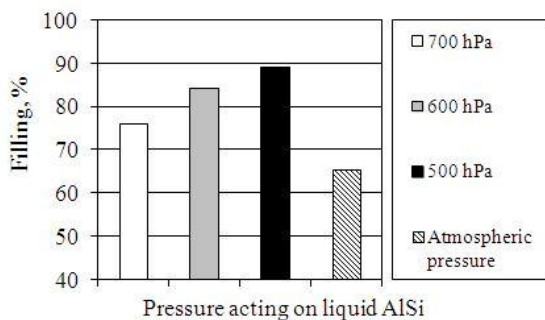

Fig. 5. Effect of pressure on filling the thin walls of casting with the liquid AlSi9 alloy

3.2. Evaluation of the filling accuracy for linear dimensions

The results of studies are shown in Figure 6. The casting dimensional deviation ΔL was defined as a difference between the maximum and minimum dimension for nominal dimensions $L_{nom} = 17.0$ mm, $L_{1nom} = 41$ mm and $L_{2nom} = 118$ mm (as shown in Figure 7). There is a clear difference between the accuracies obtained on castings made by the conventional lost wax method and in the process using back-pressure.

For example, the following values were obtained in the investment process using back-pressure:

- 1) ΔL - for $L_{1nom} = 41$ mm is 0,76 % L_{1nom} , while for the traditional process it amounts to $\Delta L_1 = 0,83$ % L_{1nom} .
- 2) ΔL - for $L_{2nom} = 118$ mm is 0,71 % L_{2nom} , while for the traditional process it amounts to $\Delta L_2 = 0,81$ % L_{2nom} .

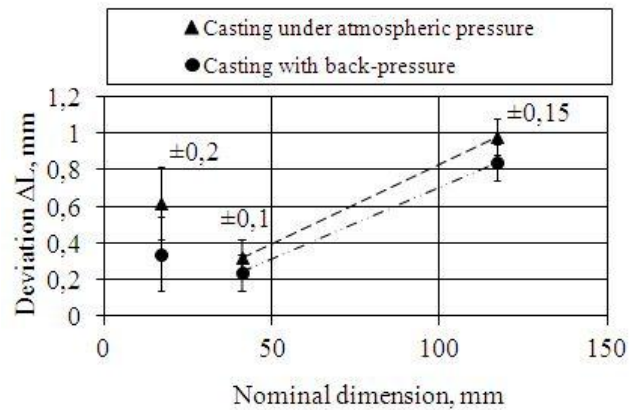

Fig. 6. Dimensional deviation ΔL in function of the nominal dimension for casting from Fig. 7

3.3. Evaluation of the accuracy of wall connection

The study was conducted on a test casting shown in Figure 7, while Figure 8 shows the geometry of the casting wall connection (two shapes with radius R), according to which the analysis was performed. The shape of the connection reflects the shape determined by the width of the ridge shown in Figure 7 (cross section A - A), where the radius R of the circles determining the connection was 7.5 mm.

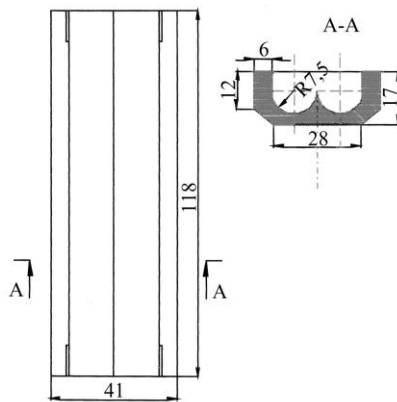

Fig. 7. Test model

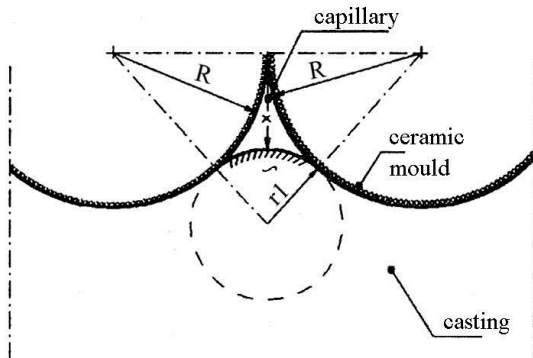

Fig. 8. The geometry of casting (according to Fig. 7), which in cross-section A - A is corresponding with its shape to a connection of casting walls reproduced by cores of radius $R = 7,5$ mm

In studies, the measured thickness was that of a connection shown in Figure 8 - hatched area. A bench microscope was used for the measurement. For 40 cast pieces, 232 thickness measurements were taken on castings made with back-pressure and 130 measurements on castings made by the traditional method. The measurements were taken every 10 mm along the longer dimension of the casting.

The thickness of the connection (0.5 mm) roughly corresponds to the radius r_1 (Fig. 8). Generally, for r_1 the following equation holds good: $r_1 = f(\sigma, \cos \theta, h, \rho, g)$, which means that the capillary phenomena have a major influence on the formation of connections [8, 9], where:

σ – the surface tension of liquid AlSi,
 $\cos \theta$ – the cosine of the ceramic mould-liquid AlSi contact angle,
 h – the pressure of liquid metal,
 ρ – the density of liquid metal,
 g – the acceleration of gravity.

The obtained values of the thickness of connection (the ridge in Fig. 7) are: $0,27^{+0,05}_{-0,03}$ mm for the process with back-pressure, and $0,48 \pm 0,06$ mm for the common lost wax process.

3.4. Evaluation of the cast surface microgeometry

Cast surface roughness measurements were taken using a profilometer made by Feinpruef Perthen GmbH. The following average results were obtained for several dozen of measurements:

- 1) for castings made in the process with back-pressure – $R_a = 1,76 \mu\text{m}$,
- 2) for castings made in the common lost wax process – $R_a = 2,83 \mu\text{m}$.

4. Summary

Practical use of casting with back-pressure gives the following benefits:

1. The increased foundry yield due to the elimination of down gate after the stage of filling the cavities with liquid metal.
2. Higher dimensional accuracy and improved cast surface quality.
3. Higher feasibility of thin-wall casting production.
4. Higher accuracy of the intricate casting wall connection.

References

- [1] R. L. Sharkey, G. D. Chandley, La coulee CLA des alliages non ferreux, Foundrie, 10/1980.
- [2] J. Taylor, The CLA process for thin – wall castings, Foundry Fokus, Int. Foundry and Forge Development, Spring 1989.
- [3] A. T. Spada, Hitchiner Manufacturing Co. – Turning the casting world upside down from Modern Casting, July 1998.
- [4] D. Chandley, Counter gravity Low – Pressure Casting, ASM Int., Vol. 15, 1992.
- [5] M. Perzyk, S. Waszkiewicz, A. Jopkiewicz, M. Kaczorowski, Odlewnictwo, WNT, Warszawa, 2004.
- [6] R. Haratym, Anizotropia właściwości form ceramicznych w aspekcie dokładności odlewów wytworzonych w procesie z przeciwcisnieniem, Archiwum Odlewnictwa, nr 15/2005.
- [7] D. Myszka, R. Haratym, Quality of investment casting made in counterback process, Acta Metallurgica Slovaca Košice, 3/2001; Ročník 7.
- [8] M. Szweycer, Zjawiska powierzchniowe w procesach odlewniczych, Wyd. Instytutu Odlewnictwa, Kraków 1996.
- [9] R. Haratym, J. Senkara, D. Sankowski, Oddziaływanie ciekłych stopów aluminkum z powierzchnią form ceramicznych na spoiwach krzemianowych, Komitet Budowy Maszyn Polskiej Akademii Nauk, Oddział w Poznaniu, Wyd. Politechniki Poznańskiej, 2001.